

FELCO 4CH - Green

- Cut & hold roses and flowers pruning shear

Made in Switzerland by FELCO

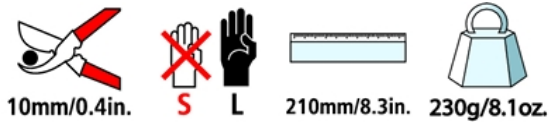

- > **Reliable:** comfortable, light, sturdy handles made of forged aluminium with a lifetime guarantee* / anvil made of of synthetic material / blade and riveted anvil blade made of high-quality hardened steel / clean, precise cut / all parts can be replaced
- > **Efficient:** cutting adjustment / wire cutting notch / sap groove
- > **Ergonomic:** non-slip coating / 2 opening positions for small or big cuts

RECOMMENDED FOR

Our recommendation (★ = Recommended, ★★ = Strongly recommended, ★★★ = Best fit)

Special applications	★★★
Small hand	★★★
Average-sized hand	★★★
Large hand	★★★
Right-handed	★★★
Left-handed	★★★

ACCESSORIES



FELCO 902
Sharpening tool
Sharpening stone



FELCO 903
Sharpening tool
Sharpener



FELCO 910
Holster
Leather - With belt loop and clip



FELCO 912
Holster
Leather - With belt clip



FELCO 980
Maintenance product
Spray







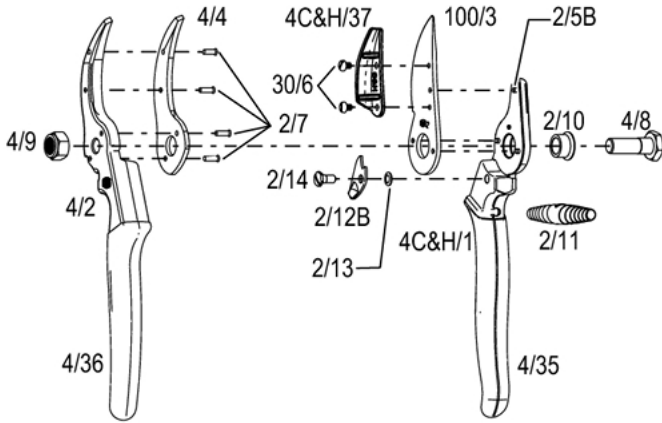



















FELCO 990
Maintenance product
Grease

SPARE PARTS



FELCO	REF.	Designation	Composition	UCC Barcode
	100/3	Blade	1x 100/3	
	4/4	Anvil-blade with rivets	1x 4/4 + 4x 2/7	
	4C&H/37	Anvil for blade	1x 4C&H/37	
	4C&H/95	Anvil with screws	1x 4C&H/37 + 2x 30/6	
	4/90	Kit	1x 4/9 + 1x 4/8	
	2/91	Kit	2x 2/11	
	2/92B	Kit	1x 2/14 + 1x 2/12B + 2x 2/13	
	4C&H/1	Handle without blade	1x 4C&H/1 + 3x 2/5B + 1x 2/10 + 1x 2/13 + 1x 2/12B + 1x 2/14 + 1x 4/35	
	4/2	Handle with anvil-blade	1x 4/2 + 1x 4/4 + 4x 2/7 + 1x 4/36	

	4/35	Coating for blade handle	1x 4/35	
	4/36	Coating for anvil-blade handle	1x 4/36	
	2/5B	Rivet for blade	1x 2/5B	
	30/6	Screw for anvil 4 mm	1x 30/6	
	2/7	Rivet for anvil-blade	1x 2/7	
	4/8	Bolt	1x 4/8	
	4/9	Nut	1x 4/9	
	2/10	Bush	1x 2/10	
	2/11	White spring	1x 2/11	
	2/12B	Thumb catch	1x 2/12B	
	2/13	Spring for thumb catch	1x 2/13	
	2/14	Screw for thumb catch	1x 2/14	

MAINTENANCE



Cleaning

It is advisable to clean your tool after each use.

If your tool is particularly dirty or subject to rusting after exposure to moisture, do not delay cleaning.



Oiling

After cleaning, it is advisable to oil the tool so as to protect it from corrosion. The oil will also unjam the tool.



Sharpening

It is advisable to sharpen your tool at least once a day, but if you feel that your tool is not cutting as well as usual, sharpen it right away!



Dismantling

It is advisable to dismantle your tool on a regular basis, but at the very latest when it appears to be jammed.

PARTS REPLACEMENT



Changing the blade

When the blade and the anvil-blade no longer cross, or when the blade is badly damaged, it is advisable to change it.

Regulate the working of the blade and anvil-blade by adjusting the tightening of the nut. The blade should rub against the anvil-blade over 2/3 of its length.



Changing the thumb catch

When the thumb catch is damaged and loosens when used, even when the screw is readjusted, change it.



Changing the plastic coatings for handles

If the coatings are badly damaged, you can replace them.

Soak the coatings for 2 minutes in boiling water - recommended glue: Loctite 415.